













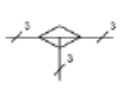



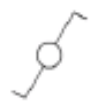

PRACTICAS DE INSTALACIONES ELÉCTRICAS

TABLA DE COMPONENTES

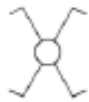
Simbolo	Nombre	Aspecto	Simbolo	Nombre	
	Regleta			Pulsador	
	Caja de empalme			Timbre	
	Toma de corriente			Conmutador	
	Punto de iluminación			Conmutador de cruce	
	Interruptor				

TABLERO DE PRUEBAS



PRÁCTICA 1: TOMA DE CORRIENTE

Esquema topográfico

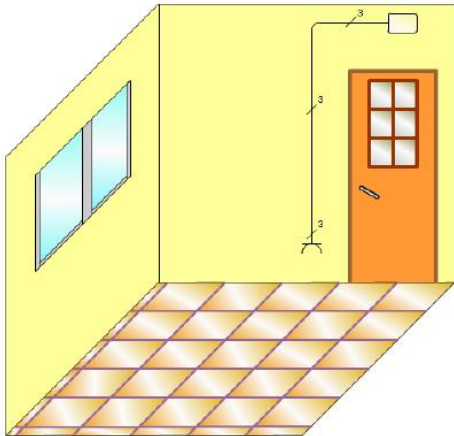

Esquema funcional del tablero

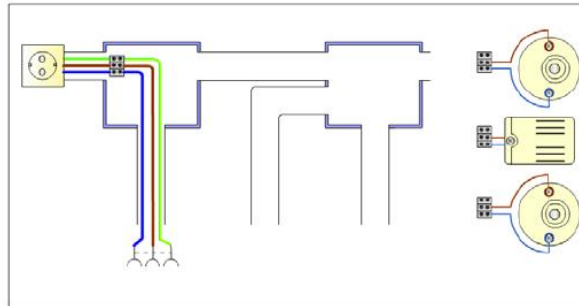

PRÁCTICA 2: PUNTO DE LUZ

Esquema topográfico

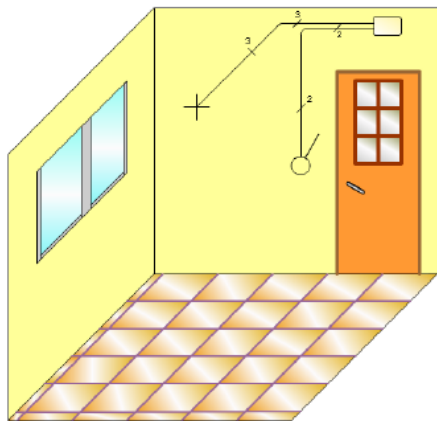

Esquema funcional del tablero

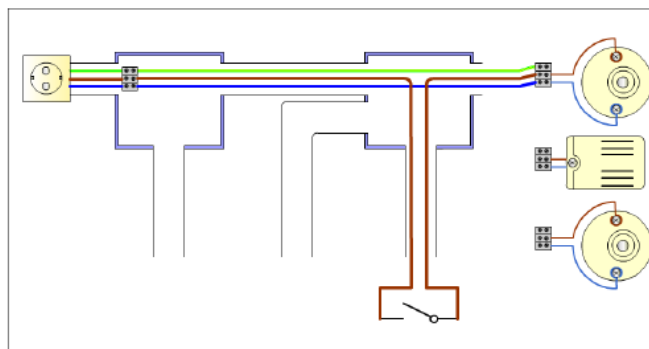

PRÁCTICA 3: 2 PUNTOS DE LUZ

Esquema topográfico

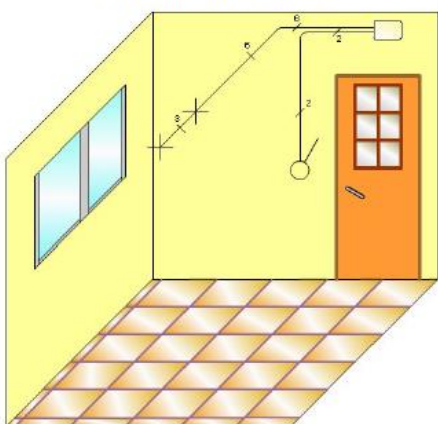

Esquema funcional del tablero

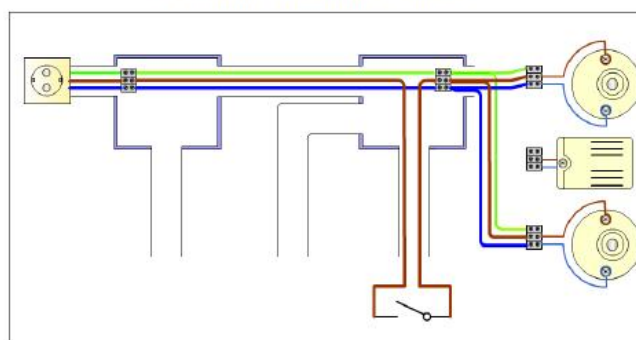

PRÁCTICA 4: PUNTO DE LUZ Y ENCHUFE

Esquema topográfico

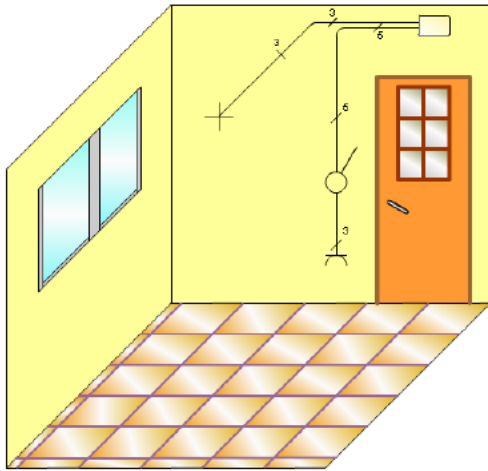

Esquema funcional del tablero

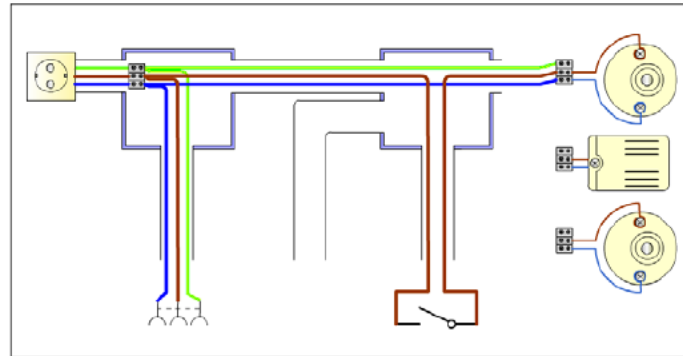

PRACTICA 5: PULSADOR Y TIMBRE

Esquema topográfico

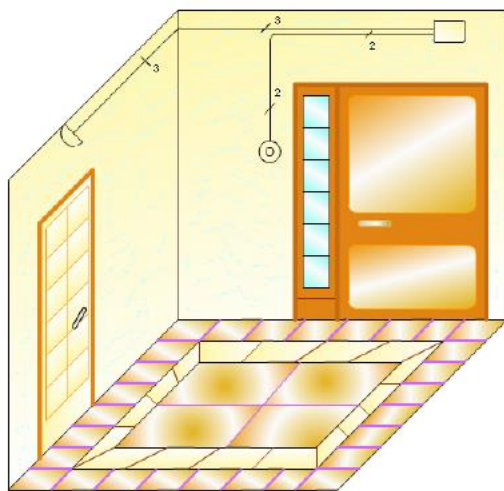

Esquema funcional del tablero

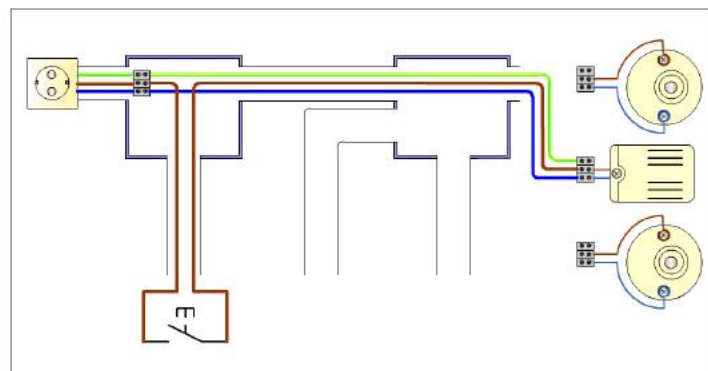

PRACTICA 6: PULSADOR E INTERRUPTOR

Esquema topográfico

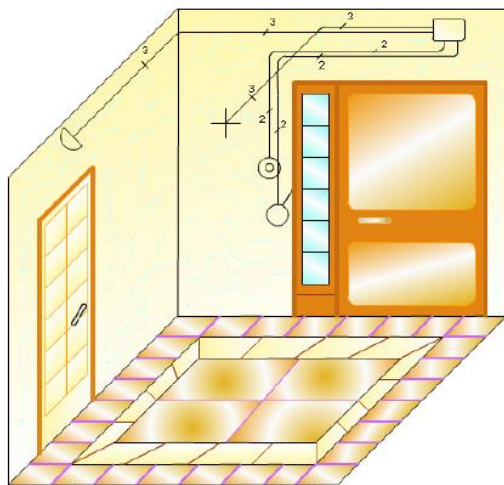

Esquema funcional del tablero

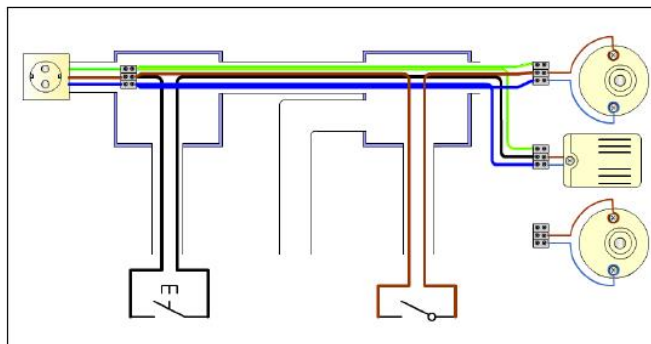

PRACTICA 7: PUNTO DE LUZ CONMUTADO

Esquema topográfico

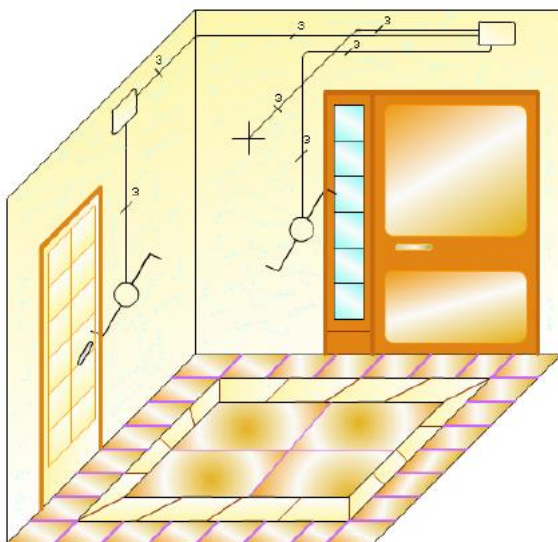

Esquema funcional del tablero

